

## Sureview 50" Slimline Pro Advertising Displays

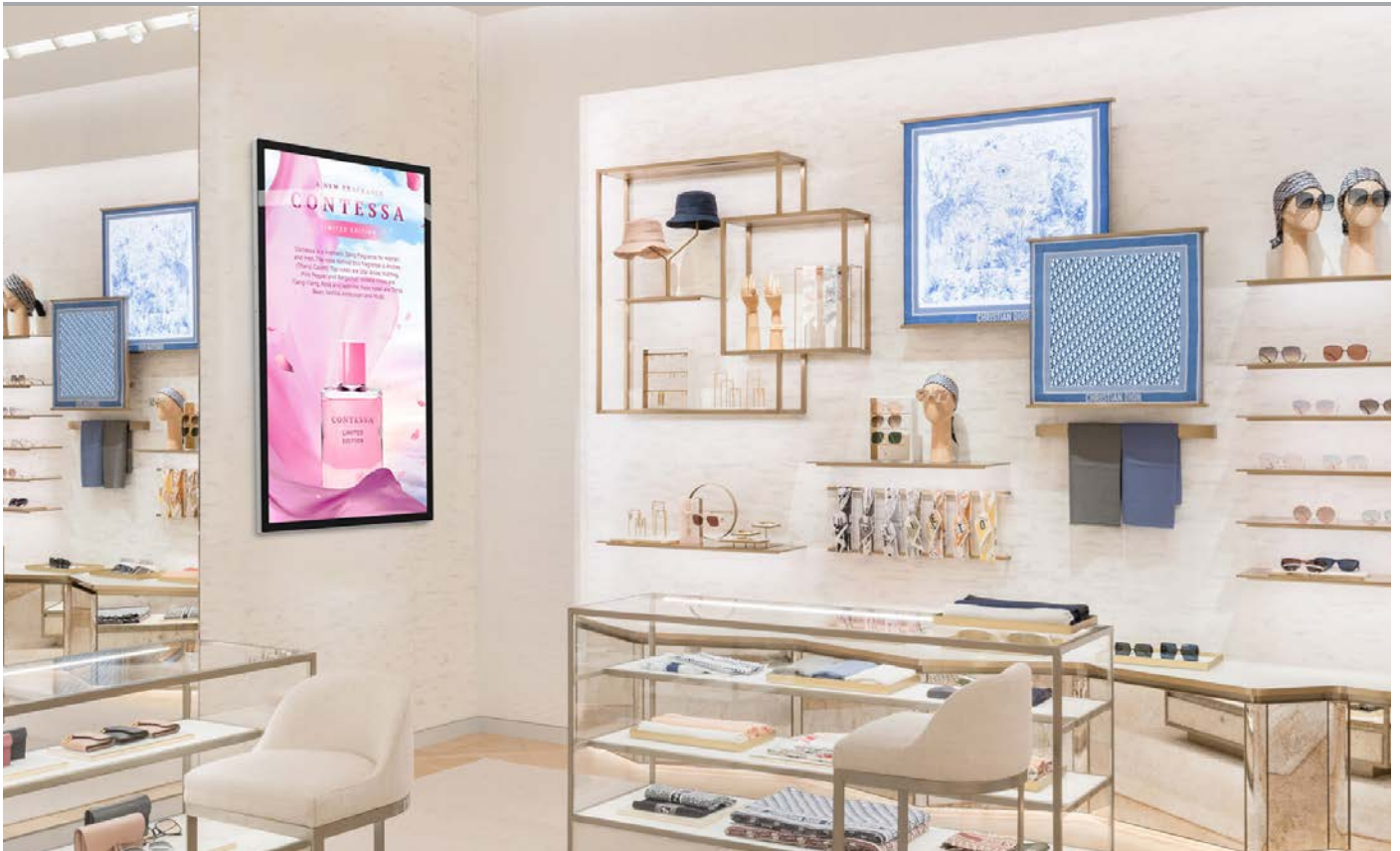

*Premium displays that combine stunning tablet-like aesthetics with a robust protective enclosure and tempered glass face*

### Protective Sleek Enclosure

These deluxe displays are the ultimate solution for displaying your content in public spaces. As well as protecting the internal components, the robust aluminium surround and tempered edge-to-edge glass also deliver captivating tablet-like aesthetics for a truly high-end feel.



### Free Flush-Fit Wall Mount

A super slim wall mount is included at no extra cost, enabling you to install your screen in either landscape or portrait orientation with a secure and aesthetically-pleasing flush fit to the wall.



24/7 Commercial Grade



Integrated Android Media Player



450cd/m<sup>2</sup> IPS Panel



Giant Tablet Styling



Lightweight Design



Free Scheduling Software



Multiple AV Inputs



Landscape or Portrait Orientation



Integrated Speakers



3 Year Commercial Warranty

## Other Features

### 24/7 Commercial Grade

Designed for continuous use in public spaces, these displays utilise commercial grade LCD panels, LED backlights and internal components. This means they can run 24/7 for over 70,000 hours. To avoid tampering, they also have no external buttons or controls.



### Integrated Android Media Player

The built-in Android media player allows you to easily update on-screen content via USB plug and play. Alternatively, upgrade your screen to be networked without needing any additional hardware to update via the internet. Third-party software can also be installed if required.



### 450cd/m<sup>2</sup> IPS Panel

Commercial grade IPS technology ensures incredible image quality and colour depth with no fall-off in colour accuracy, as well as achieving ultimate lifelike colour from an ultra-wide viewing angle in landscape or portrait orientation.



### Lightweight Design

By using less and lighter materials, component weight is kept to a minimum. This compact design makes both installation and maintenance much more convenient.



### Toughened Safety Glass

Although the tempered glass face is incredibly tough, in the unlikely event of a breakage the specialised safety glass will shatter into small chunks rather than shards. Not only does this prevent injury, it also protects the LCD panel from damage.



### Slender Frame

Featuring a slim frame with rounded corners, these displays achieve giant tablet styling while also minimising frame size to keep focus squarely on your content.



### Aluminium Surround

Thanks to their stunning surround, which is made of diamond-cut 6-series aluminium alloy and has a premium brushed finish, as well as their unique concave indent profile, these displays are truly distinguishable. Sculpting the surround from a single piece, rather than in segments, achieves a cleaner finish.



### Multiple AV Inputs

By connecting to an external device via HDMI or VGA, such as a third-party PC or media player, these versatile displays can be effortlessly transformed into a commercial monitor with striking aesthetics.

- 1 LAN
- 2 HDMI
- 3 VGA
- 4 Audio in
- 5 2 x USB

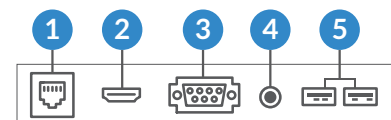

Key Features



GIANT TABLET STYLING



24/7 COMMERCIAL USE



INTEGRATED SPEAKERS



450CD/M<sup>2</sup> IPS PANEL



LANDSCAPE OR PORTRAIT ORIENTATION



TOUGHENED SAFETY GLASS



SLENDER FRAME

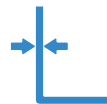

LIGHTWEIGHT DESIGN



UNIQUE CONCAVE INDENT PROFILE



FREE FLUSH-FIT WALL MOUNT



INTEGRATED ANDROID MEDIA PLAYER



CONNECT EXTERNAL DEVICES

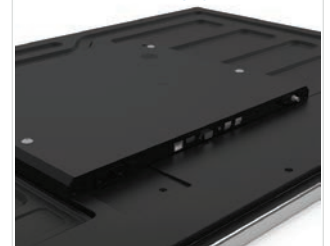

## Specification Table

		50 Inch
Panel	Resolution	1920x1080
	Display Area (mm)	1072.8x603
	Aspect Ratio	16:9
	Brightness (cd/m <sup>2</sup> )	450
	Colour	16.7M
	Viewing Angle	178°
	Contrast Ratio	5000:1
Audio	Speaker Type	2x2W 4Ω
AV Inputs	Video	HDMI, VGA
	Audio	Audio Socket (3.5mm)
Power	Power Consumption (W)	70
	Input Voltage	AC110~240V (50Hz~60Hz)
Mechanical	Unit Size (WxHxD mm)	1135.2x665.4x63.2
	Package Size (WxHxD mm)	1279.2x818x199
	VESA Holes (mm)	400x400/400x200
	Net Weight (kg)	27.1
	Gross Weight (kg)	32.79
Environmental	Operating Temperature	0 °C to 50 °C
	Storage Temperature	-30°C to 60°C
	Operating Humidity	10% to 80%
	Storage Humidity	5% to 95%
Computer	Media Formats	Video (MPG, AVI, MP4, RM, RMVB, TS), Audio (MP3, WMA), Image (JPG, GIF, BMP, PNG)
	Media Resolution	1920x1080/1080x1920
	CPU	Quad-Core ARM Cortex A17, 1.6GHz
	GPU	Quad-Core ARM Mali-T764
	RAM	DDR3 2GB
	Internal Storage	8GB eMMC
	USB	1 x USB (OTG/HOST), 1 x USB (HOST)
	LAN	100M/1000M Ethernet (Network Version Only)
	Wi-Fi	802.11b/g/n/ac (Network Version Only)
	Bluetooth	Bluetooth 4.0
	OS	Android 7.1
	Graphic Engine	OpenGL ES 1.1/2.0/3.0/3.1, OpenCL 1.1, Renderscript, Direct3D 11.1
	Accessories	Included
Optional		Network Upgrade, Touch Screen Version, Wall Mount, Floor Stand/Trolley, Ceiling Mount, Table Stand
Warranty	Warranty Period	3 Year Warranty
	Technical Support	Lifetime

Errors and omissions excepted



Technical Drawing

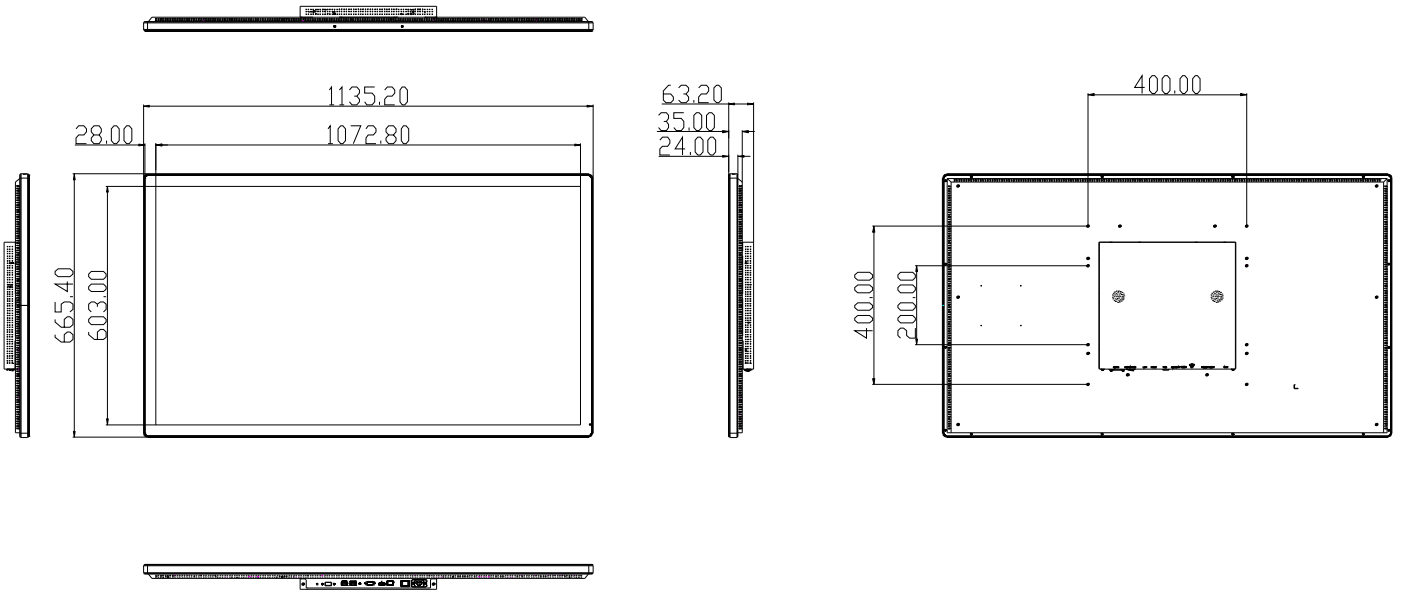

## Why Choose Our Commercial Display Solutions?



### Lifetime Technical Support

From the moment you receive your product, throughout the duration of your warranty and even after your warranty has expired we are here to support you. If you require any assistance setting up or using your product, or have any problems at all, we can provide free technical support via telephone and email.

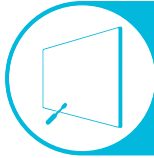

### On-site Support and Maintenance\*

If needed, we can provide an installation service for any of our products. We can also set up service-level agreements for larger projects that require maintenance contracts.



### Extended Warranty\*

All of our commercial display products come with a 3 year commercial warranty as standard but if you want to extend this you can upgrade this to cover a 5 year period at point of purchase.



### Training

As well as providing free remote CMS training sessions and webinars we can also visit you to deliver bespoke training for our software and hardware\*.



### Advanced Replacements†

Should your display suffer from any kind of hardware failure during the warranty period we will send you an advanced replacement and arrange for your old display to be collected, free of charge. This ensures no downtime where you are without a screen.



### Custom Product Testing & Configuration

If you need us to test third party software or a website, or configure your screen in a particular way before it is dispatched (e.g. in a particular orientation or network mode), we can do so to make your life easier.



### 3D Rendering

Want to know how a particular screen will look once installed? Send us a photo of the location and we will create a 3D rendering of any screen in situ to help you to visualise how amazing it will look.



### Logistics Support

We hold more stock in our UK warehouse than any other manufacturer so we can help you meet tight deadlines. For last minute orders we can also offer special express or morning delivery options\*. We also carry out UK based quality control checks on every display before it leaves our warehouse.



### Project Support

If you need to loan a sample unit to test we'd be more than happy to arrange this. We can also provide a rental service for temporary projects\*.



### Customisation\*

Your display can be customised to suit your requirements by adding your logo or printed graphics or even tailoring the colour of a display. We can also carry out hardware modifications to existing products or manufacture bespoke solutions for special projects.

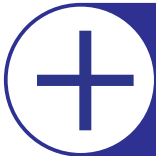

### Extras\*

As well as being able to provide accessories and add-ons, such as extra remote controls, NUC PCs and video wall controllers, we can also supply custom made flight cases which are great if a display needs to be moved safely from place to place.